

TT121 | Lighter Socket Mount with Power Dongle for TomTom GPS



Package Contents:

- (1) GN097-SBH - 12V - 24V / Lighter socket mount with power outlet
- (1) APTTO - Adapter plate for TomTom ONE™ Series
- (1) APTTOXL - Adapter plate for TomTom ONE XL / XL-S™ Series
- (1) APTGO520 - Adapter plate for TomTom GO™ Series
- (1) APTTSE - Adapter plate for TomTom EasyPort™ Series
- (1) APTTSE - Adapter plate for TomTom Start™ and Ease™

TomTom Device Compatibility:

TomTom ONE 125 125-SE (TomTom EasyPort Mount)
 TomTom ONE 130, ONE 130-S (TomTom EasyPort Mount)
 TomTom ONE 140, ONE 140-S (TomTom EasyPort Mount)
 TomTom XL 325, XL 325-S, XL 325-SE (TomTom EasyPort Mount)
 TomTom XL 330, XL 330-S (TomTom EasyPort Mount)
 TomTom XL 335 Series (TomTom EasyPort Mount)
 TomTom XL 340, XL 340-S, XL 340 LIVE Series (TomTom EasyPort Mount)
 TomTom XL 350 Series (TomTom EasyPort Mount)
 TomTom XXL 530-S, XXL 535-T, XXL 540-S/WTE, XXL 550 Series (TomTom EasyPort Mount)
 TomTom ONE (US Edition, US 3rd Edition)
 TomTom ONE XL (1st Edition) - TomTom ONE XL-S (1st Edition)
 TomTom ONE 22, ONE 22 Regional, ONE 22 Regional Traffic
 TomTom XL 22, XL 22 Regional (TomTom EasyPort Mount)
 TomTom ONE UK / EUROPE (NEW Edition aka 2nd Edition, 3rd Edition)
 TomTom GO 520 / 530 / 630 / 720 / 730 / 920 / 920T / 930
 TomTom Start and Ease

TomTom, ONE, GO, and EasyPort, Start and Ease are product names, trademarks, or registered trademarks of TomTom International b.v. Arkon Resources, Inc. is not affiliated with TomTom International b.v.

Mount Installation Instructions

- Step 1. Insert the DC Power plug (A) completely into the vehicle's 12V-24V / lighter socket.
- Step 2. Adjust the angle of the pedestal arm by tightening the wing nut (B) to the desired placement angle.

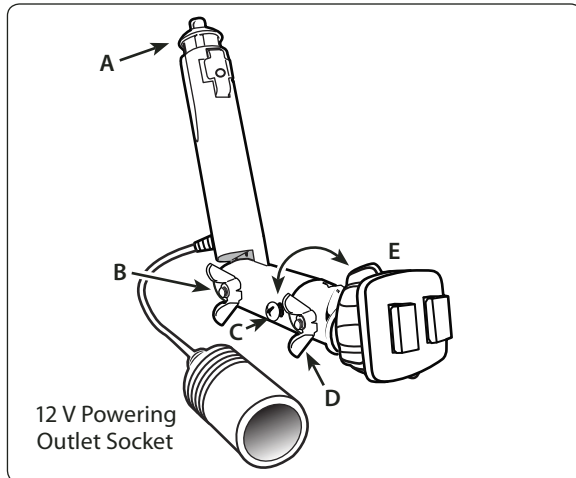

- Step 3. If necessary, adjust the rotation of the mounting head by tightening the screw (C) with a screwdriver.
- Step 4. Adjust the angle of the pedestal head by tightening the wing nut (D) to the desired angle.
- Step 5. Adjust the angle of the pedestal head by tightening the adjustment ring (E).
- Step 6. Insert the car charger that came with your TomTom into the power dongle outlet on the mount.

TomTom ONE, ONE XL, and ONE XL-S Plate Installation

- Step 1. Slide the adapter plate up into the grooves on the back of the TomTom ONE, ONE XL, or ONE XL-S device.

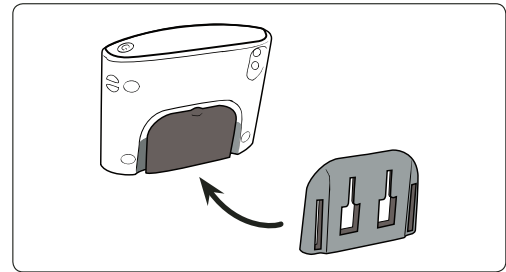

TomTom GO Adapter Plate Installation

- Step 1. Attach the adapter plate by sliding it up into the slot on the back of the TomTom GO 520, 530, 630, 720, 730, 920, 920T or 930 device as shown. Attach the device as shown below.

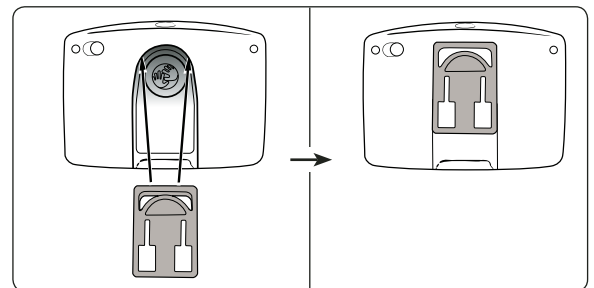

Continued on other side...



Safety Precautions

Do not install Arkon products over an air bag cover or within the air bag deployment zone. Arkon Resources, Inc. assumes no responsibility of liability for injury or death as a result of car crashes and/or air bag deployment.

Arkon is not responsible for any damages caused to your car, your device, or yourself due to the installation or use of this pedestal mount.

ARKON
RESOURCES INC.

The Mobile Mounting Specialists™

Consumer Hotline:

USA (800) 841-0884

INT'L (626) 254-9005

Monday - Friday 9am - 5pm, PST

www.arkon.com

Arcadia, CA 91006 USA

Designed in USA | Made in China and Taiwan

© Copyright 2010 Arkon Resources, Inc.

TT121 | Lighter Socket Mount with Power Dongle for TomTom GPS

TomTom EasyPort Adapter Plate Installation

Step 1. Connect the dual T-slots (A) on adapter plate to the dual T-tabs (B) on the pedestal head. Adjust the angle of the head by tightening the head adjustment knob (C).

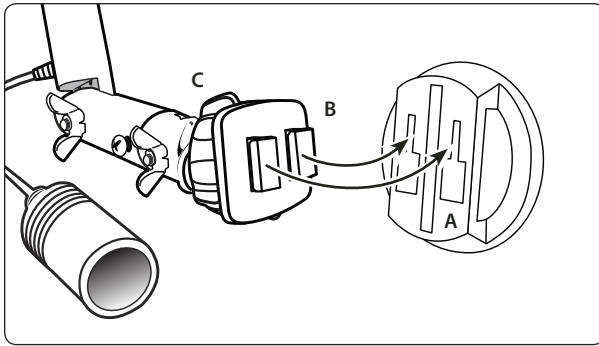

Step 2. While holding the mounted TomTom adapter plate, gently insert the TomTom device (not included, sold separately) into the adapter plate until an audible click is heard.

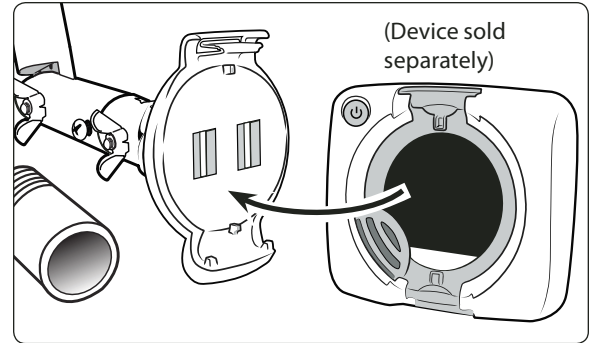

TomTom EasyPort Device Insertion

Step 1. While holding the mounted adapter plate, gently insert the device (not included, sold separately) into the adapter plate until an audible click is heard. The device can then be rotated into the desired viewing angle.

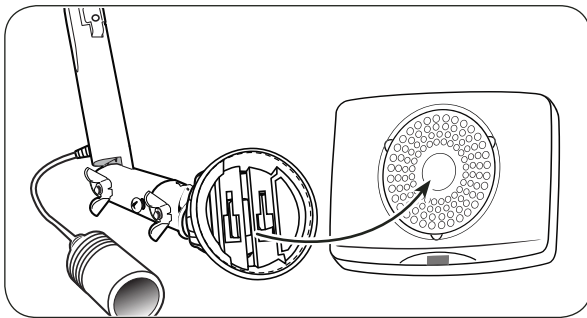

TomTom Adapter Plate Attachment

Step 1. Attach the TomTom dual-T adapter plate to the mount by inserting the dual-T tabs of the mount (A) into the dual-T slots on the adapter plate (B).

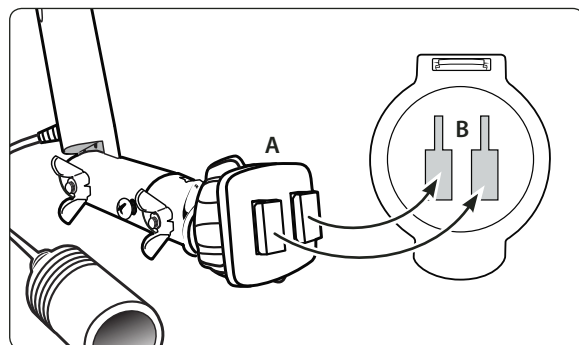

Safety Precautions

Do not install Arkon products over an air bag cover or within the air bag deployment zone. Arkon Resources, Inc. assumes no responsibility of liability for injury or death as a result of car crashes and/or air bag deployment.

Arkon is not responsible for any damages caused to your car, your device, or yourself due to the installation or use of this pedestal mount.

ARKON[®]
RESOURCES INC.

The Mobile Mounting Specialists™

Consumer Hotline:

USA (800) 841-0884

INT'L (626) 254-9005

Monday - Friday 9am - 5pm, PST

www.arkon.com

Arcadia, CA 91006 USA

Designed in USA | Made in China and Taiwan

© Copyright 2010 Arkon Resources, Inc.