

SR047-SRVC | Satellite Radio Vent Mount



CM047-S Vent Mount Pedestal (fully assembled)



AP012 2-Way to 4-Hole AMPS Adapter Plate (for Sirius, and other devices without a T-slot)

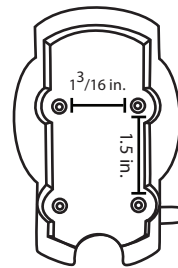
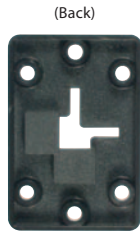

A typical 4-Hole AMPS pattern (Cradle not included)

Package Contents:

- (1) CM047-SRVC Vent Mount Assembly
- (1) AP012 2-Way T-Slot to 4-Hole AMPS Adapter Plate
- (4) Screws for adapter plate

NOTES:

- 1. This vent mount kit is not compatible with circular air vents.

Installation Instructions

Step 1. Choose a suitable vent location for installation. Attach the vent mounting clips to the back of the pedestal with the vent clips correctly positioned with the flat sides facing up.

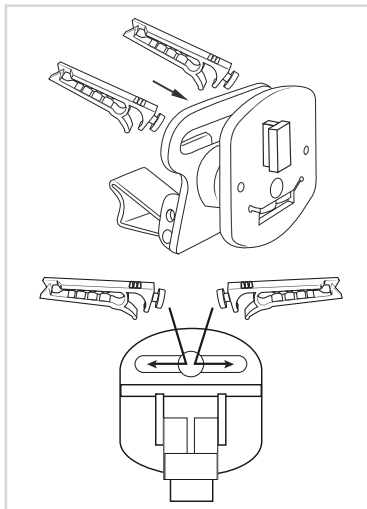

Step 2. Pinch the vent mounting clips (A) so that the teeth open and gently insert vent pedestal into vent louvres until the mounting clips are attached to the fin/blade of the vent. Adjust the spacing between the mounting clips if necessary. Adjust the support leg (B) vertically until it rests firmly along the bottom of the vent or dash surface below the vent. It will need to support the weight of the cradle and device.

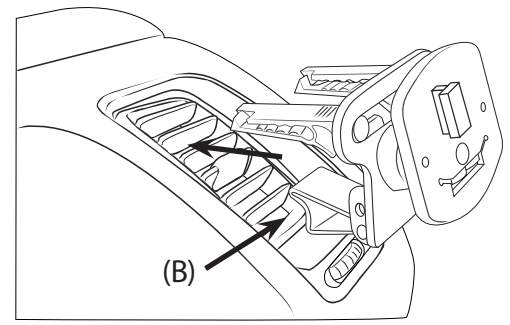
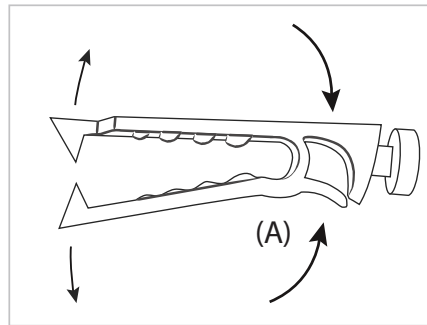

Warning: Arkon is not responsible if the vent louvres become damaged as a result of the installation or use of this mount.

Step 3. For Sirius devices, attach the adapter plate to the back with the included screws.

Step 4. While holding the pedestal's swivel mechanism, align the T-tab on the pedestal face to the T-slot on the back of the device or adapter plate (Sirius only).

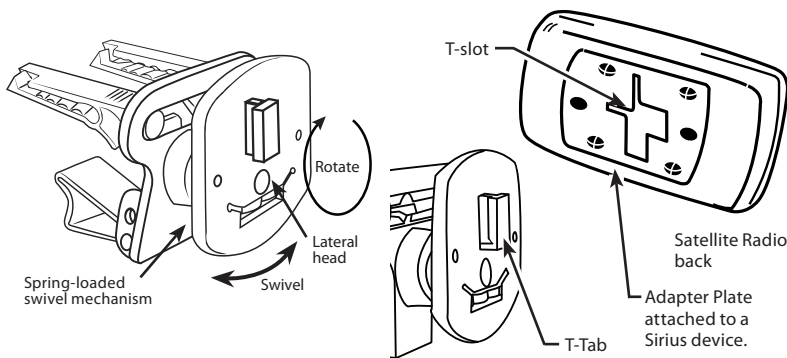

Removal of Vent Clips

When removing the pedestal, use the utmost care when trying to remove the vent clips so as not to damage your vehicle.

1. Remove the device from the vent mount assembly.
2. Pinch the vent clips at point (C) as shown in (fig. 1) so that the teeth open.

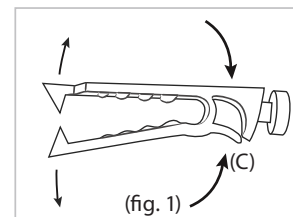

3. Carefully slide the pedestal from the vent fin/blade. Make sure the teeth of the vent clips are open enough so that they clear without damaging the vent.

Safety Precautions

Do not reposition the pedestal while driving. Arkon Resources, Inc. does not promote the adjustment of hand-held devices except when the vehicle is safely parked or stopped.

Arkon is not responsible for any damages to your vehicle, your device, or yourself resulting from the installation or use of this product.

ARKON
RESOURCES INC.

The Mobile Mounting Specialists™

Consumer Hotline:
(USA) (800) 841-0884
(INT'L) (626) 254-9005

www.arkon.com
Arcadia, CA 91006 USA
Made in Taiwan

Mon-Fri. 9am-5pm, PST © Copyright 2007 Arkon Resources, Inc.