

SM525-S | Flexible Gooseneck Seat Bolt or Floor Mount for Phones and Smartphones



Package Contents:

- (1) CM088-TS-2 - 15" Flexible steel gooseneck floor or console mount
 - Includes: (1) Seat Bolt Bracket, (1) Floor / Console Bracket, (4) Screws, (4) Plastic Caps, and (1) Flexible Steel Shaft with Plastic Tubing
- (1) SM050-2 - Slim-Grip™ holder for Smartphones
- (1) SP-CM088-SBH 360° Swivel SBH Head (optional)
- (1) SP-SM050-LF - Extra Long Support Legs (2 Pack) for larger phones

Holder included is Universal, designed to fit nearly ALL non-flip mobile phones regardless of whether a protective case or silicone sleeve is attached to the phone.

- Most smartphones, mobile phones, and cell phones having heights between 80mm and 115mm tall
- Apple iPhone - All models
- RIM BlackBerry - All non-flip models
- HTC Phones - All non-flip models
- Motorola Phones - All non-flip models
- Nokia Mobile Phones - All non-flip models
- Palm - All non-flip models
- LG Mobile Phones - All non-flip models
- Samsung - All non-flip models
- Sony Ericsson - All non-flip models
- Sanyo - All non-flip models
- Pantech - All non-flip models
- Google - All non-flip models

! Do not place mount in or near an air bag deployment zone or where it will obstruct view of the road.

All brand names and product names are trademarks or registered trademarks of their respective owners.

1 Passenger Seat Bolt Mounting

For a simple mount that can be easily moved to another vehicle, install using the passenger seat track bolt.

! Do not place mount in or near an air bag deployment zone or where it will obstruct view of the road.

- Step 1. Screw the flexible steel shaft into the seat track bolt bracket.
- Step 2. With a socket wrench, loosen the passenger seat track bolt, insert the seat track bolt bracket, and retighten the seat track bolt.

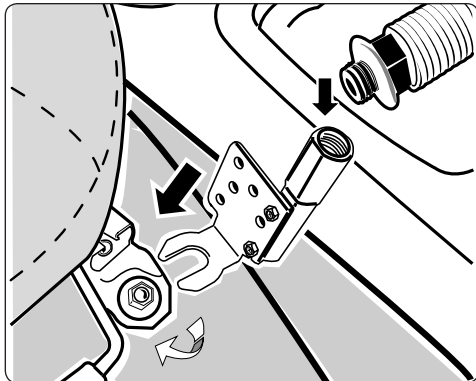

2 Floor or Console Mounting

For a more permanent mount, connect the Floor / Console Mount Bracket to the floor or console. This will require drilling into your vehicle's interior surface.

! Drilling into the dash, floor, or console will permanently damage the vehicle. Use caution and consult a mobile install professional to avoid drilling into the gas tank, electrical system or other highly sensitive vehicle components.

! Safety Precautions

Do not install Arkon products over an air bag cover or within the air bag deployment zone. Arkon Resources, Inc. assumes no responsibility of liability for injury or death as a result of car crashes and / or air bag deployment.

Arkon is not responsible for any damages caused to your car, your device, or yourself due to the installation or use of this pedestal mount.

- Step 1. Position the Floor/Console Bracket and drill into the floor or console.
- Step 2. Attach the Floor / Console Bracket with screws and cover with plastic caps.
- Step 3. Screw the steel shaft into the Floor / Console Bracket.

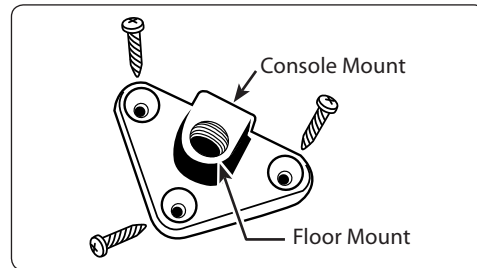

3 Pedestal Head Adjustments

- Step 1. Adjust the steel shaft by bending with both hands to the desired location of the male dual T head.
- Step 2. Use the adjustment knob and wing nut on the pedestal head to swivel or rotate the head position if necessary.

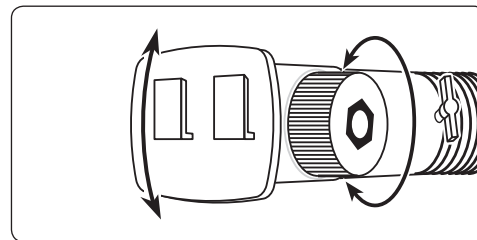

Continued on other side...

ARKON
RESOURCES INC.

The Mobile Mounting Specialists™

Consumer Hotline:

USA (800) 841-0884

INT'L (626) 254-9005

Monday - Friday 9 am - 5 pm, PST

www.arkon.com

Arcadia, CA 91006 USA

Designed in USA | Made in China and Taiwan

© Copyright 2010 Arkon Resources, Inc.

Install the Support Legs to the Holder

Step 1. Insert the holder support legs (A) by sliding them into the support leg grooves (B) on the top and bottom of the holder.

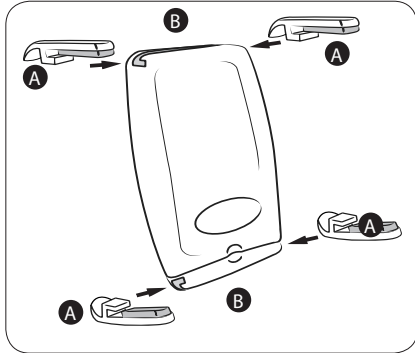

iPhone Holder Attachment

Step 1. Connect the dual T-slots (C) on the back of the holder to the dual T-tabs (D) on the mount pedestal head.

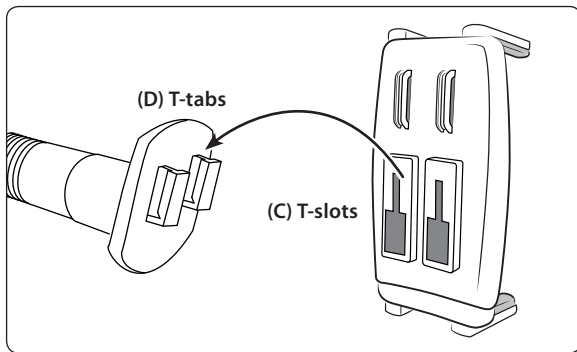

Insert Phone into Holder

Step 1. Secure holder with your hand for support, as spring-loaded mechanism requires significant force to operate. Hold your phone and insert into universal holder by pushing down on the bottom spring-loaded support legs with moderate amount of pressure (E). Slide the top of the device under the top support legs (F) until it fits snugly in the holder.

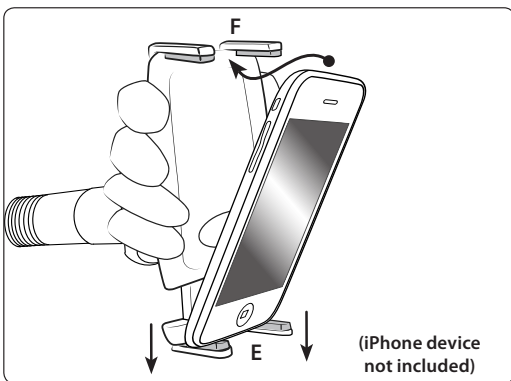

Adjusting Holder to Fit Phone

Step 1. If necessary, adjust the support legs (G) on top and bottom by sliding them laterally to avoid any buttons or ports that may be on your phone.

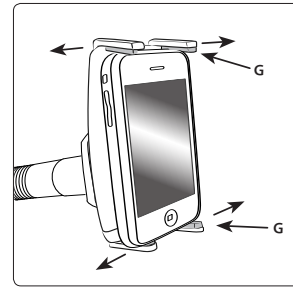

Using the Optional 360° Swivel SBH Head for Landscape Viewing

Step 1. To rotate your device in landscape view, install the optional SP-CM088-SBH 360° swivel SBH head. Unscrew the wing nut on the gooseneck and remove the already installed tilt swivel head. Insert the SP-CM088-SBH 360° swivel SBH head and retighten the gooseneck wing nut. Adjust the angle of the 360° swivel SBH head with the head wing nut and swivel adjustment ring as necessary.

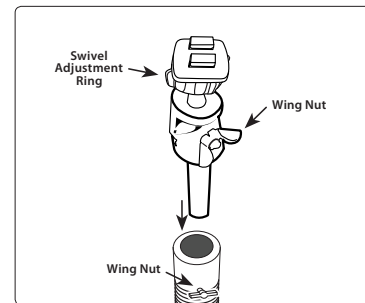

Fitting for Larger Phones

Step 1. For larger phones such as the T-Mobile G2 and Motorola Droid X, install the two included extra long support legs. Insert the extra long support legs (A) by sliding them into the support leg grooves (B) on the top and bottom of the holder.

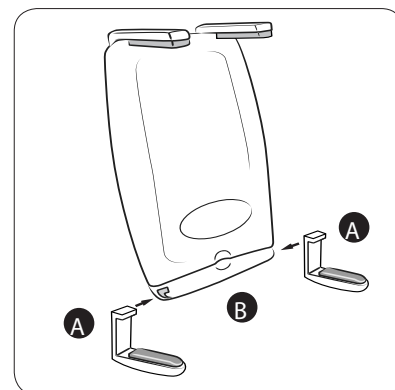

! Safety Precautions

Do not install Arkon products over an air bag cover or within the air bag deployment zone. Arkon Resources, Inc. assumes no responsibility of liability for injury or death as a result of car crashes and /or air bag deployment.

Arkon is not responsible for any damages caused to your car, your device, or yourself due to the installation or use of this pedestal mount.



Consumer Hotline: www.arkon.com
 USA (800) 841-0884 Arcadia, CA 91006 USA
 INT'L (626) 254-9005 Designed in USA | Made in China and Taiwan
 Monday - Friday 9 am - 5 pm, PST © Copyright 2010 Arkon Resources, Inc.